

We Energies Non-Purchase Rate - customer owned generation solar one-line diagrams

Notes:

- The inverter shall be UL 1741 compliant.
- The external disconnect shall provide a visible open between its contacts, have the ability to be locked in the open position and have 24/7 ready access for utility workers.
 - Breakers (including breakers integrated in metering equipment) and air conditioner “pull out” disconnects are not acceptable.
- If the PV Disconnect Switch is not located within sight of the Utility Meter, a placard must be placed at both the meter and disconnect switch indicating the location with respect to the other. In cases where a feeder serves generation on another building, both buildings require disconnects and placards.
- Please list the one-line diagram number (example: “NP3”) that is referenced on the submitted one-line diagram.
- Example one-line diagrams show the minimum required alternating current disconnects.
- One-line diagram must meet the minimum requirements of PSC 119.10
- Single phase inverters are not allowed on three phase services.
- When an updated/new one-line is submitted for review that one-line shall take precedence over all previous one-lines and will need to comply with the current requirements.
- By installing customer owned generation the customer/installer agree to address any existing issues with metering/service equipment to meet current requirements.
- One-line diagram should be located near metering equipment and protected from the environment as a permanent placard or in a weather tight enclosure.
 - A one-line diagram shall be posted onsite for energy storage systems or systems with multiple disconnect switches.

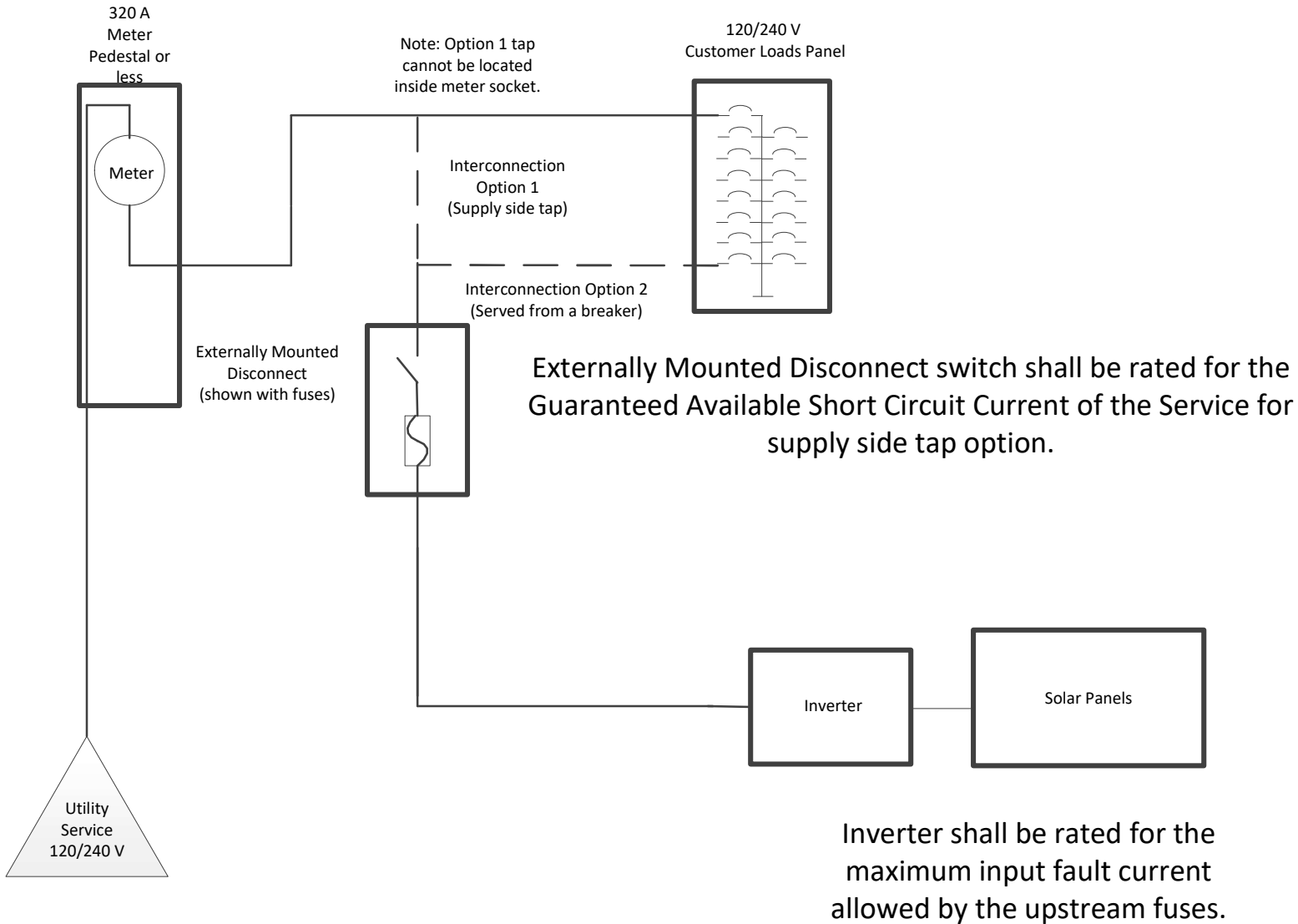

Note: One-line diagram must show the metering equipment and disconnect catalog numbers.

One Line Diagram – Non-Purchase Rate – NP1
 Solar with a 320A meter pedestal or less
 (320A, 240V 3-wire single phase service)

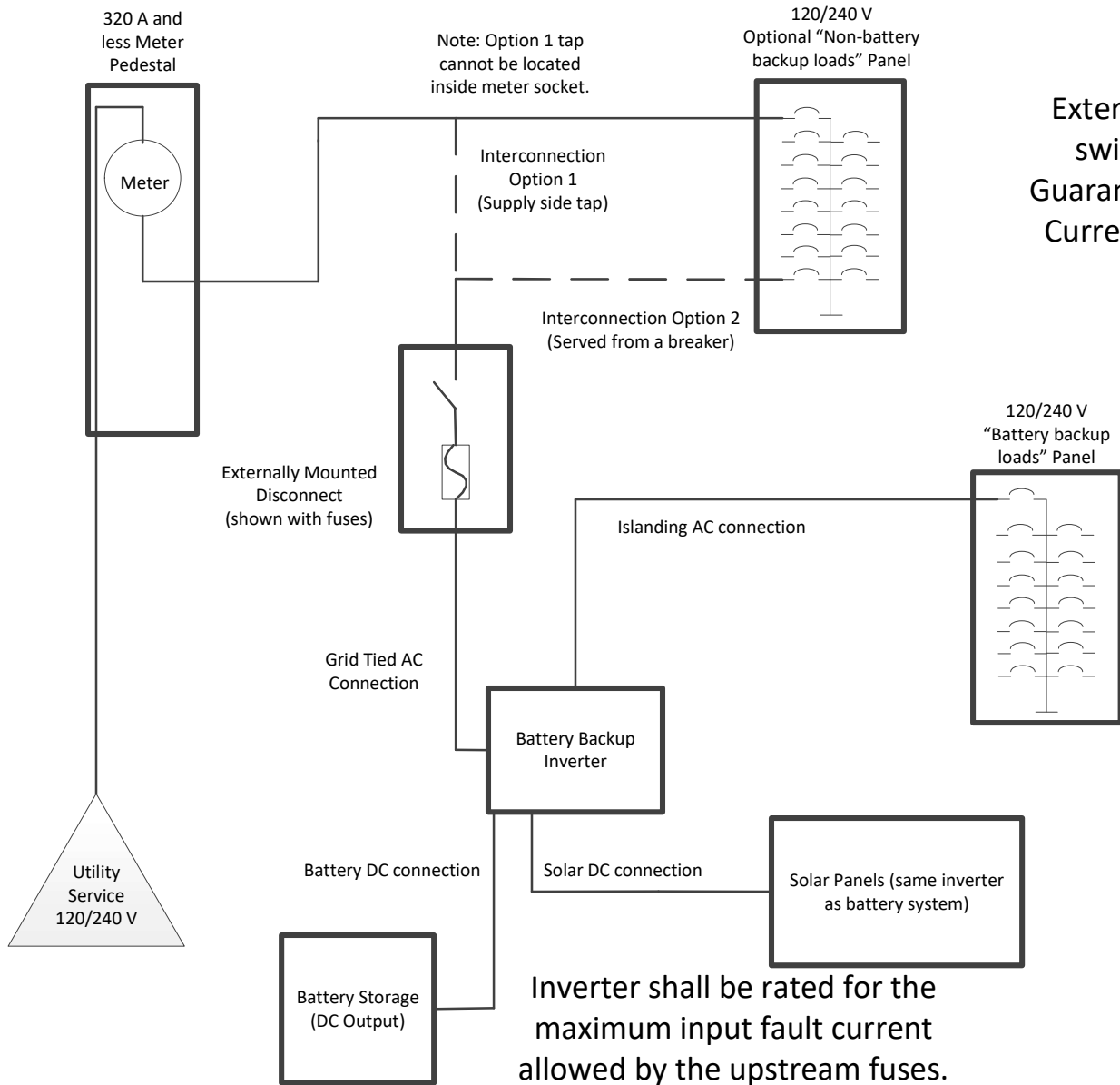

Externally Mounted Disconnect switch shall be rated for the Guaranteed Available Short Circuit Current of the Service for supply side tap option.

Inverter shall be rated for the maximum input fault current allowed by the upstream fuses.

Note: One-line diagram must show the metering equipment and disconnect catalog numbers.

One Line Diagram – Non-Purchase Rate – NP2
Solar with Battery Back-up with shared inverter
(240V 3-wire single phase service)

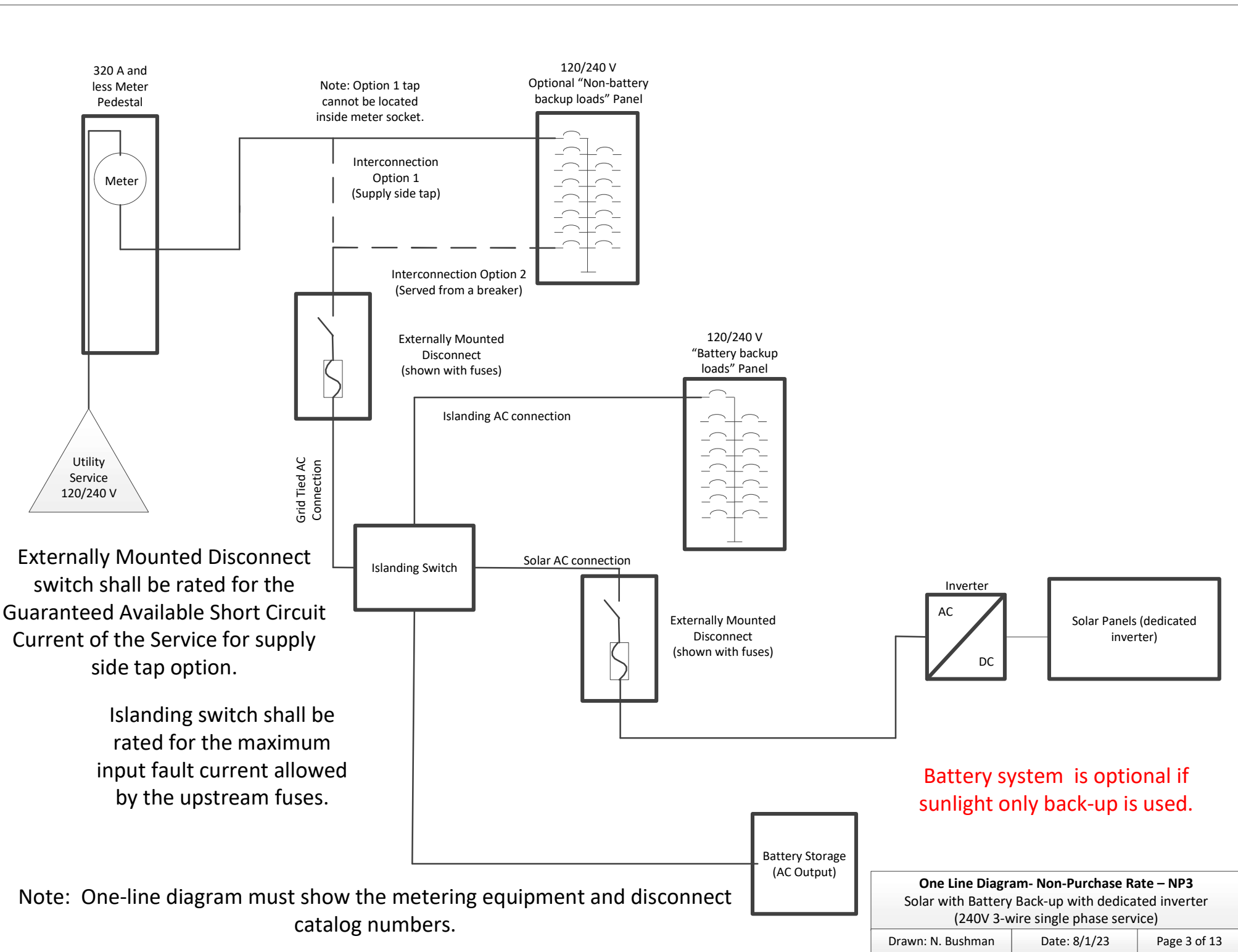

Externally Mounted Disconnect switch shall be rated for the Guaranteed Available Short Circuit Current of the Service for supply side tap option.

Islanding switch shall be rated for the maximum input fault current allowed by the upstream fuses.

Note: One-line diagram must show the metering equipment and disconnect catalog numbers.

Battery system is optional if sunlight only back-up is used.

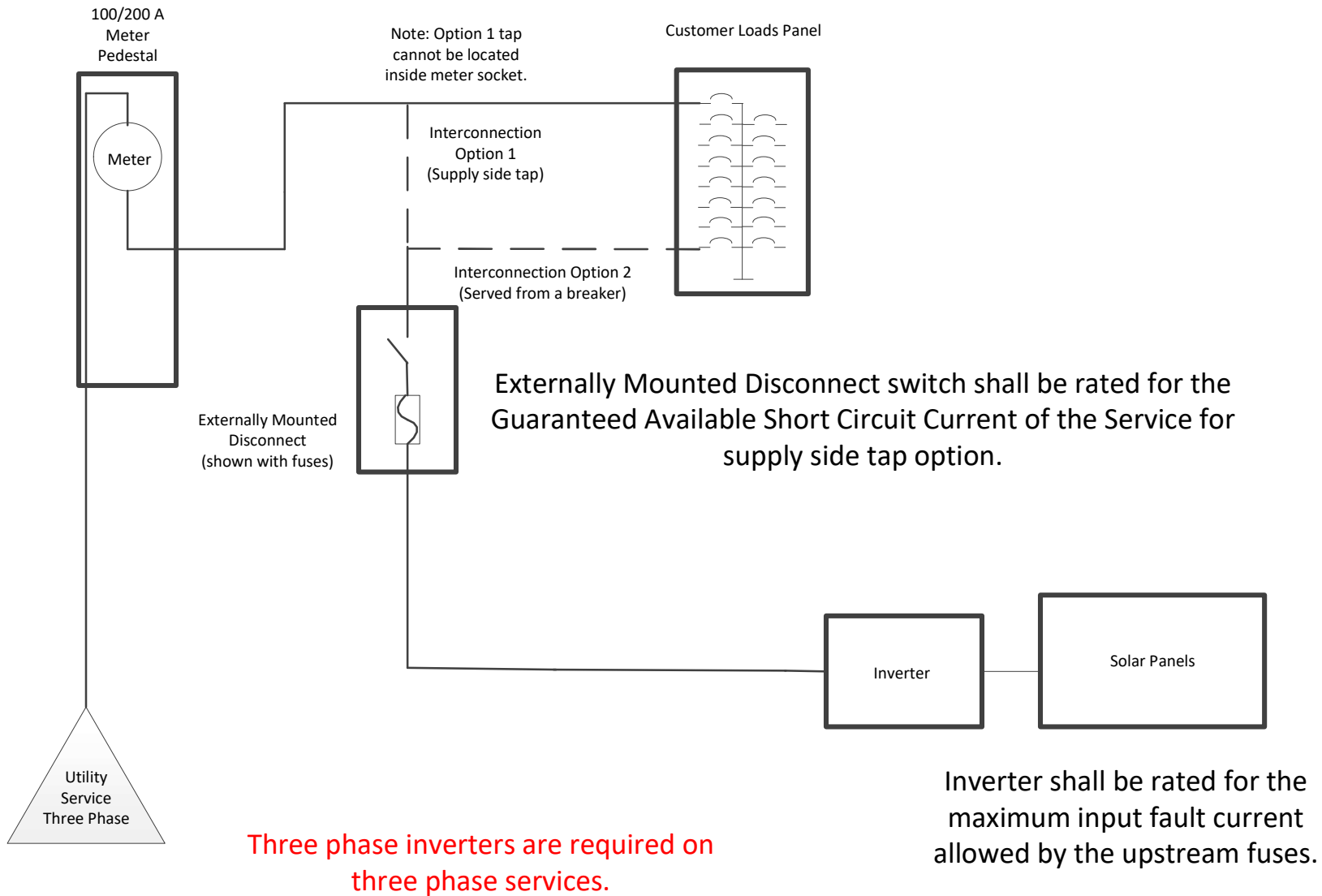

Note: One-line diagram must show the metering equipment and disconnect catalog numbers.

One Line Diagram – Non-Purchase Rate – NP4		
Three phase solar (Three phase 200A and less Service)		
Drawn: N. Bushman	Date: 4/26/23	Page 4 of 13

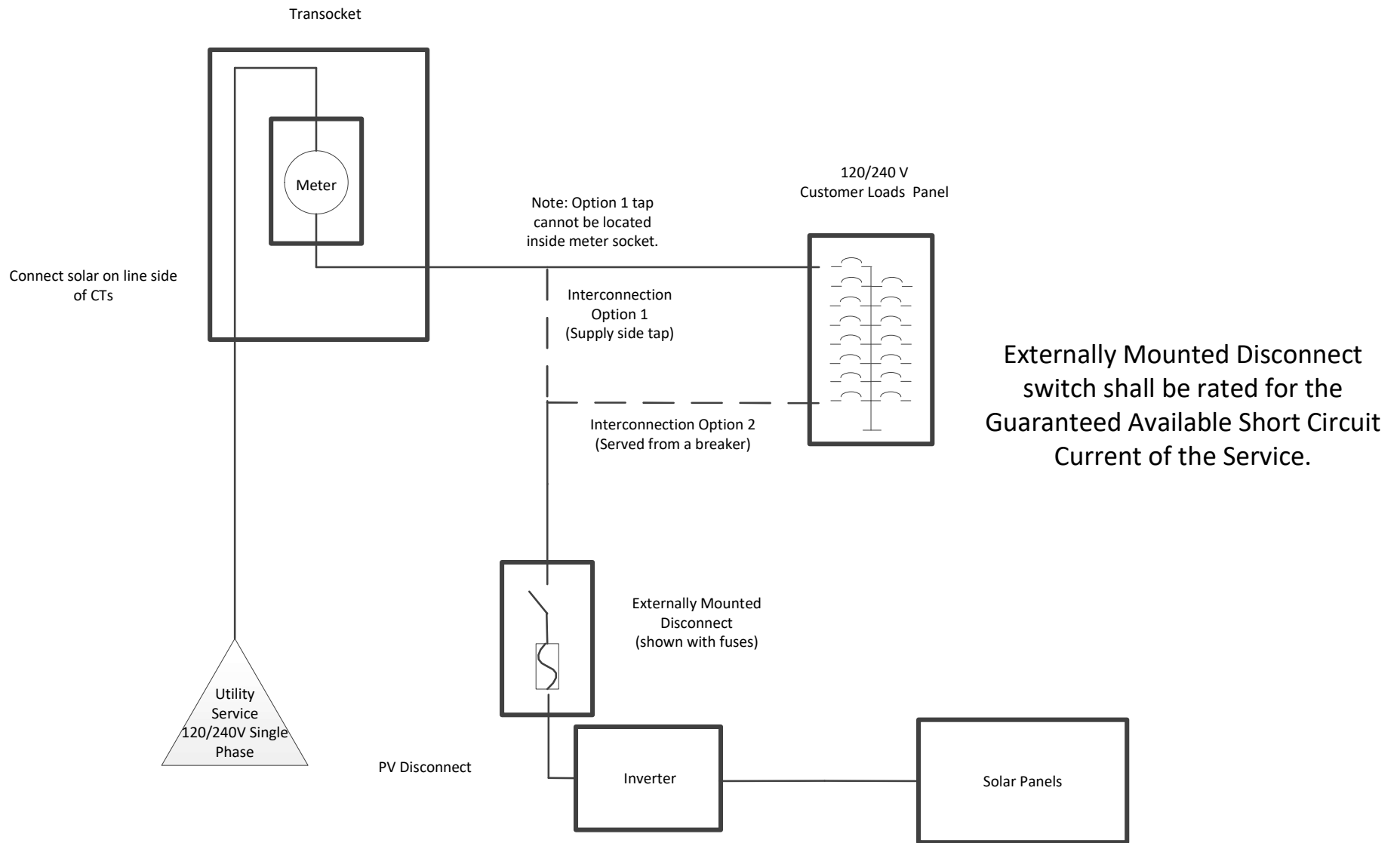

Note: One-line diagram must show the metering equipment and disconnect catalog numbers.

One Line Diagram – Non-Purchase Rate – NP5
 Solar with transocket
 (Single Phase Service 400-800A)

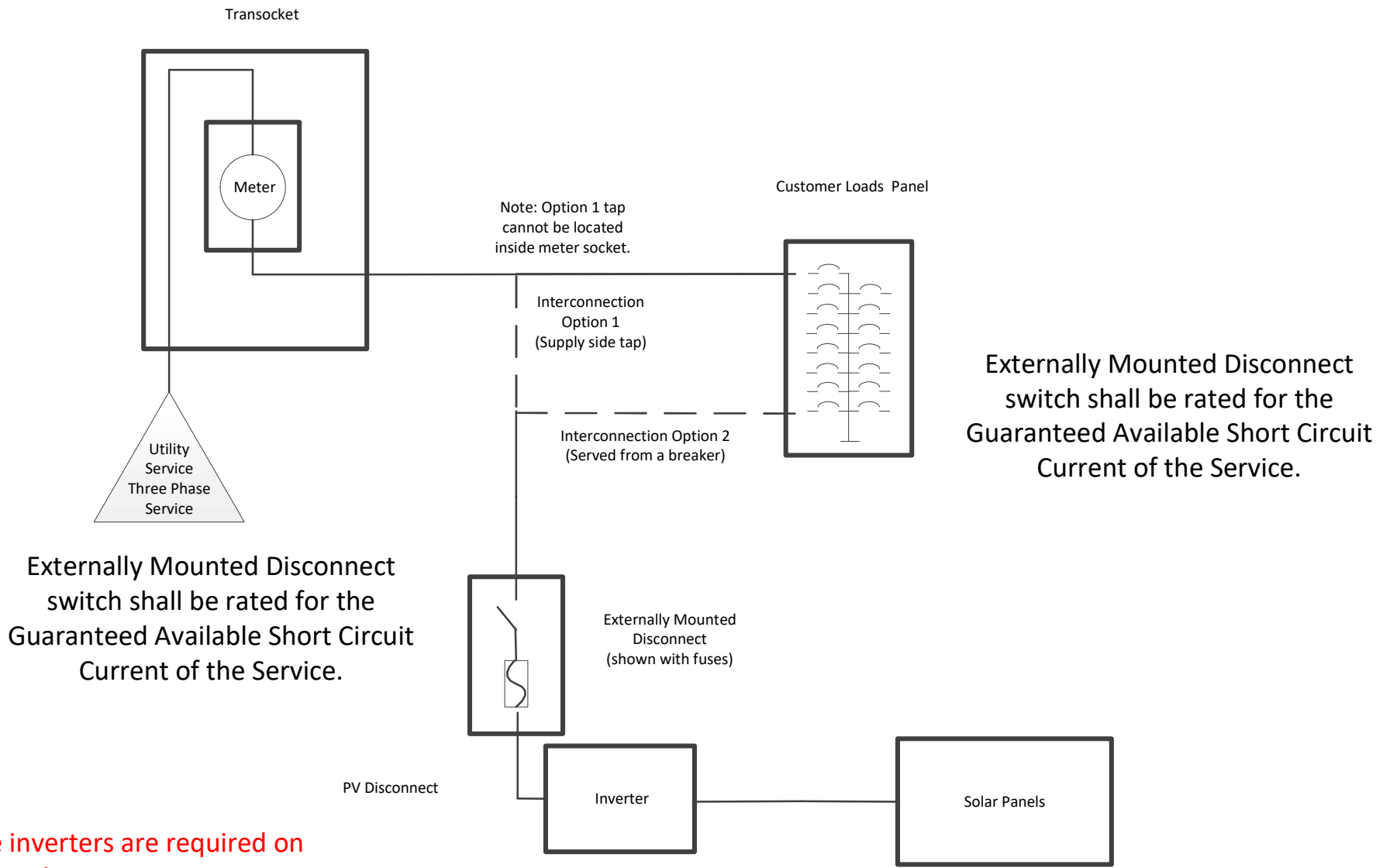

Three phase inverters are required on three phase services.

Note: One-line diagram must show the metering equipment and disconnect catalog numbers.

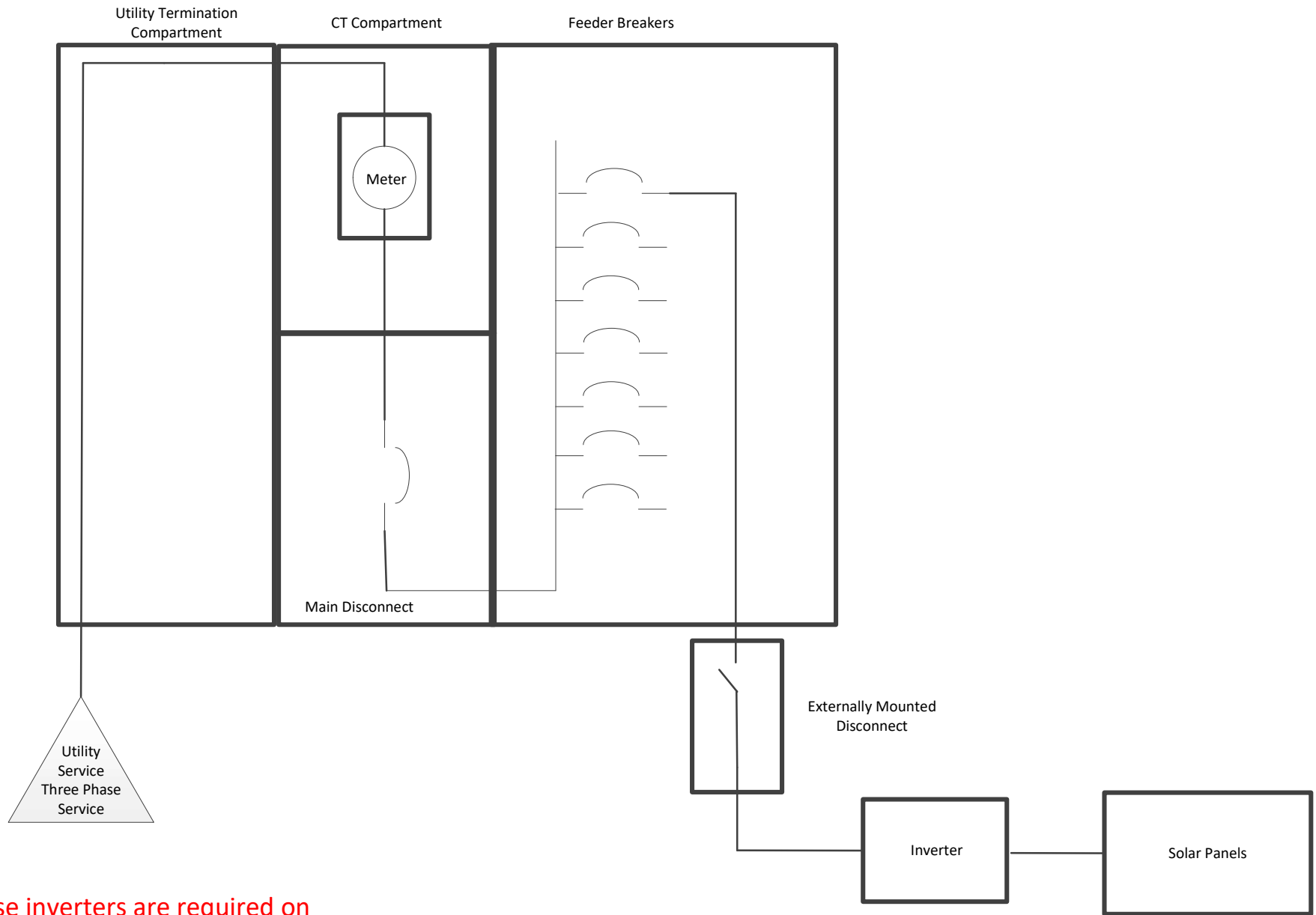

Three phase inverters are required on three phase services.

Note: One-line diagram must show the metering equipment and disconnect catalog numbers.

One Line Diagram – Non-Purchase Rate – NP7
Solar with switchgear.
(4-wire three phase service)

Drawn: N. Bushman

Date: 4/26/23

Page 7 of 13

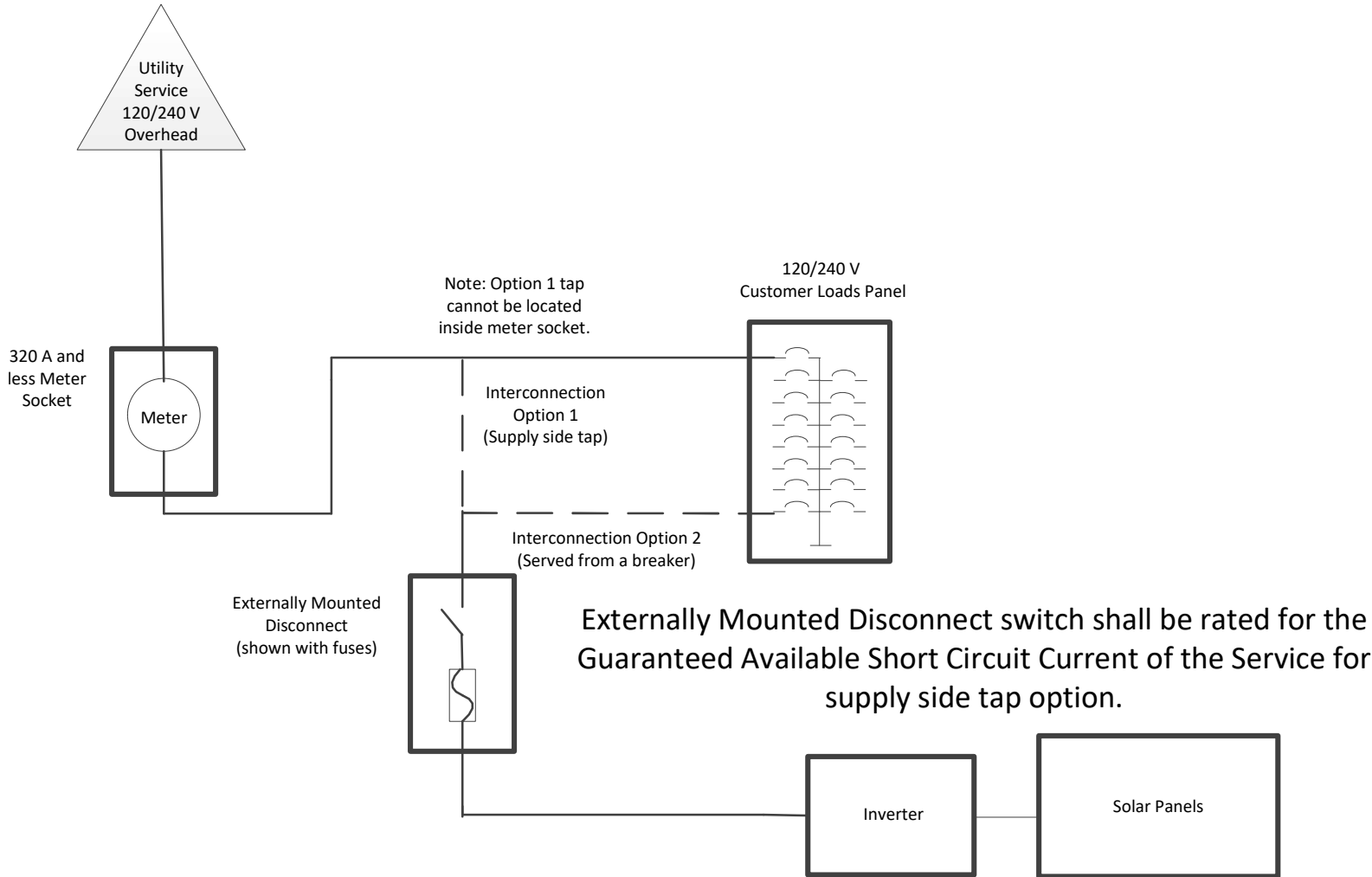

Note: One-line diagram must show the metering equipment and disconnect catalog numbers.

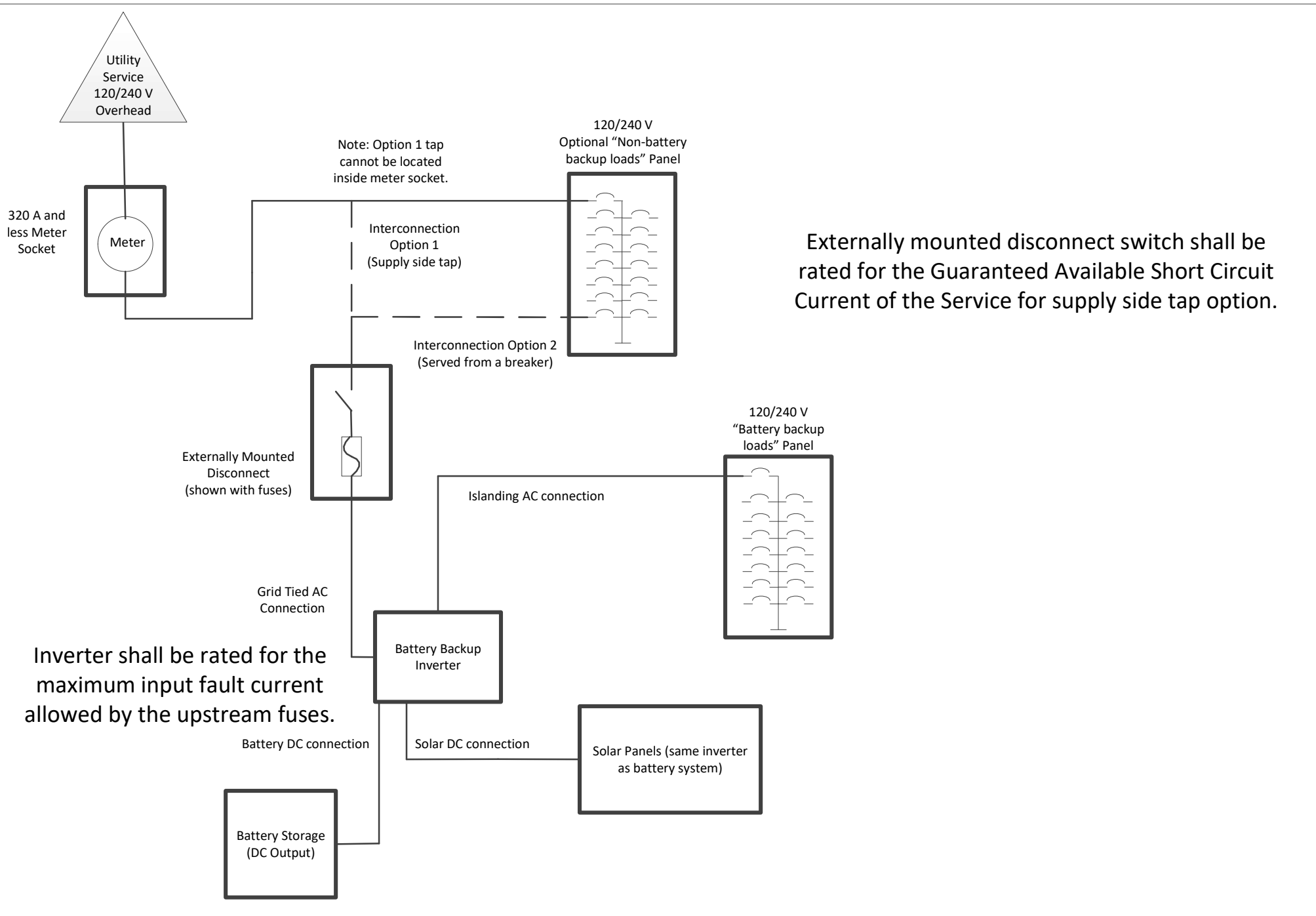

Inverter shall be rated for the maximum input fault current allowed by the upstream fuses.

Note: One-line diagram must show the metering equipment and disconnect catalog numbers.

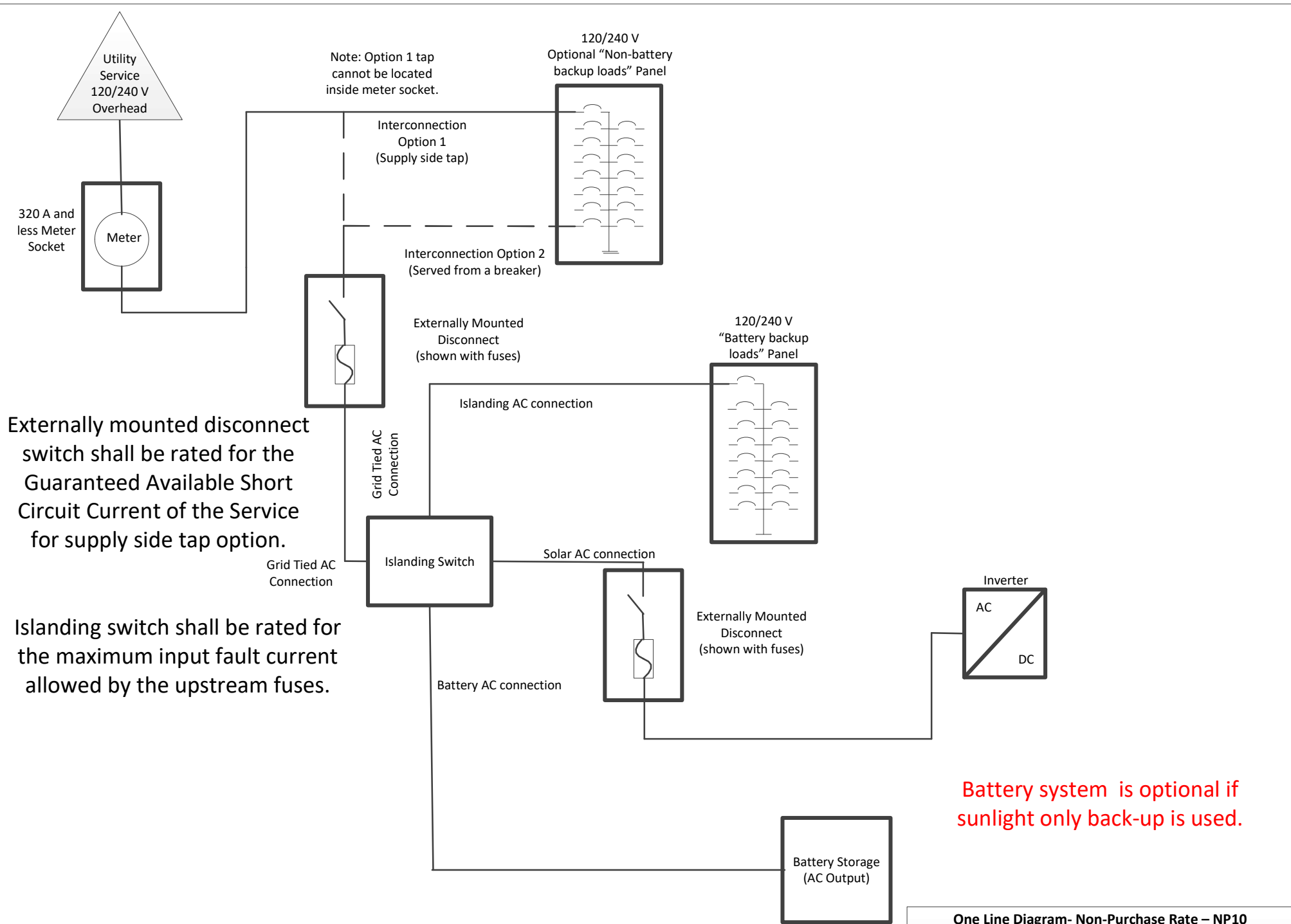

Externally mounted disconnect switch shall be rated for the Guaranteed Available Short Circuit Current of the Service for supply side tap option.

Islanding switch shall be rated for the maximum input fault current allowed by the upstream fuses.

Note: Option 1 tap cannot be located inside meter socket.

Battery system is optional if sunlight only back-up is used.

Note: One-line diagram must show the metering equipment and disconnect catalog numbers.

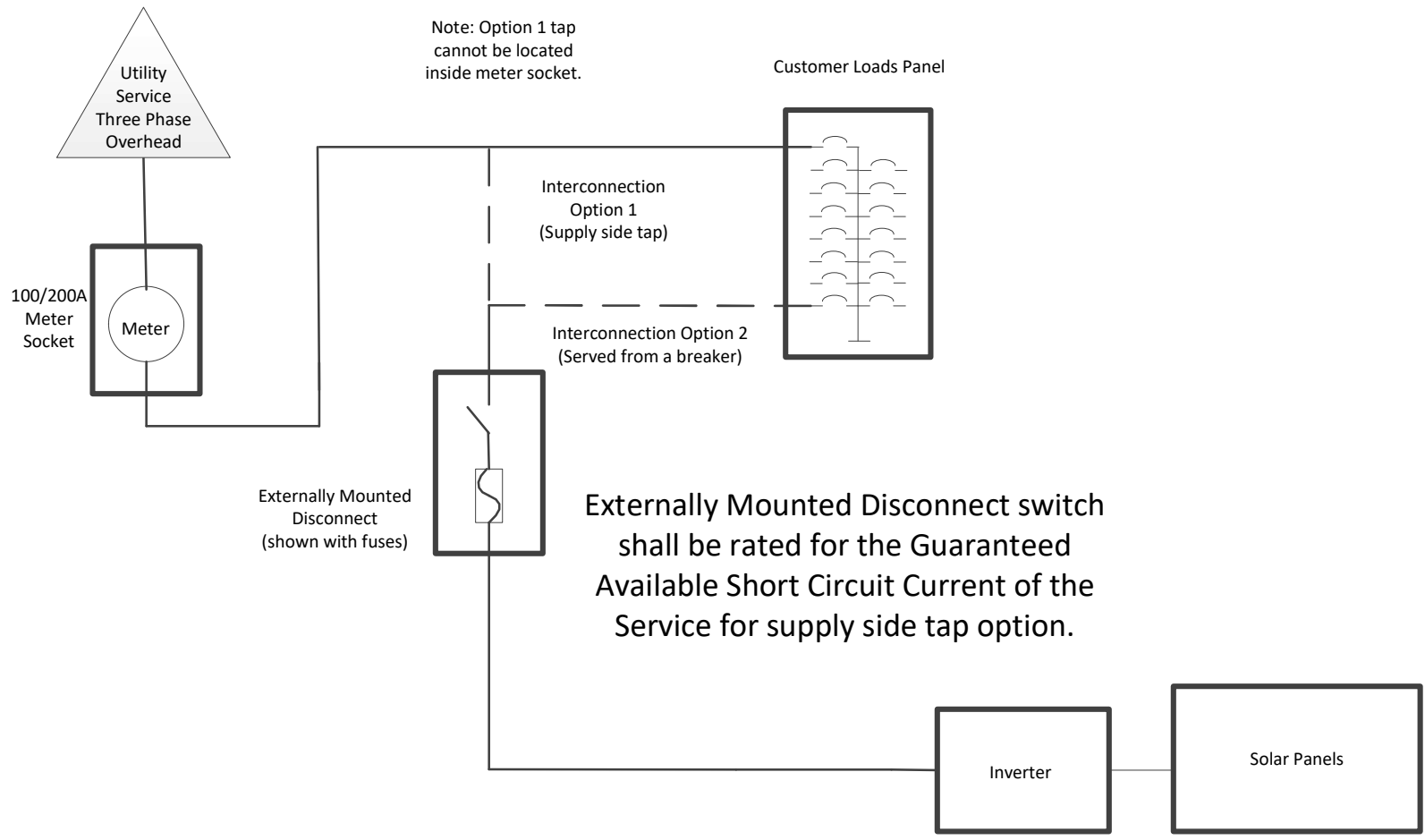

Three phase inverters are required on three phase services.

Note: One-line diagram must show the metering equipment and disconnect catalog numbers.

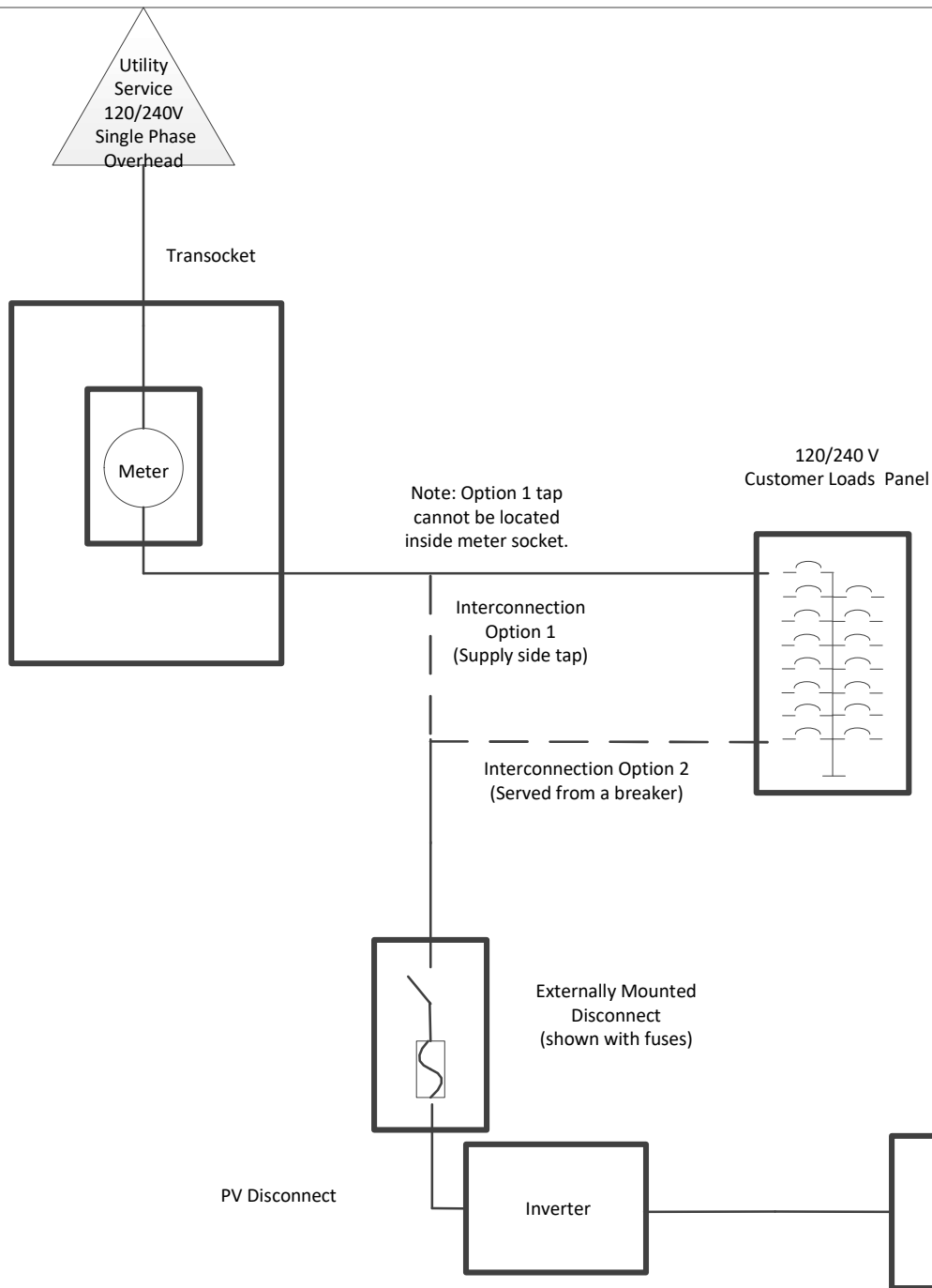

Externally Mounted Disconnect switch shall be rated for the Guaranteed Available Short Circuit Current of the Service.

Note: One-line diagram must show the metering equipment and disconnect catalog numbers.

One Line Diagram –Non-Purchase Rate – NP12
Solar with transocket
(Single Phase Service 400-800A)

Drawn: N. Bushman

Date: 4/26/23

Page 12 of 13

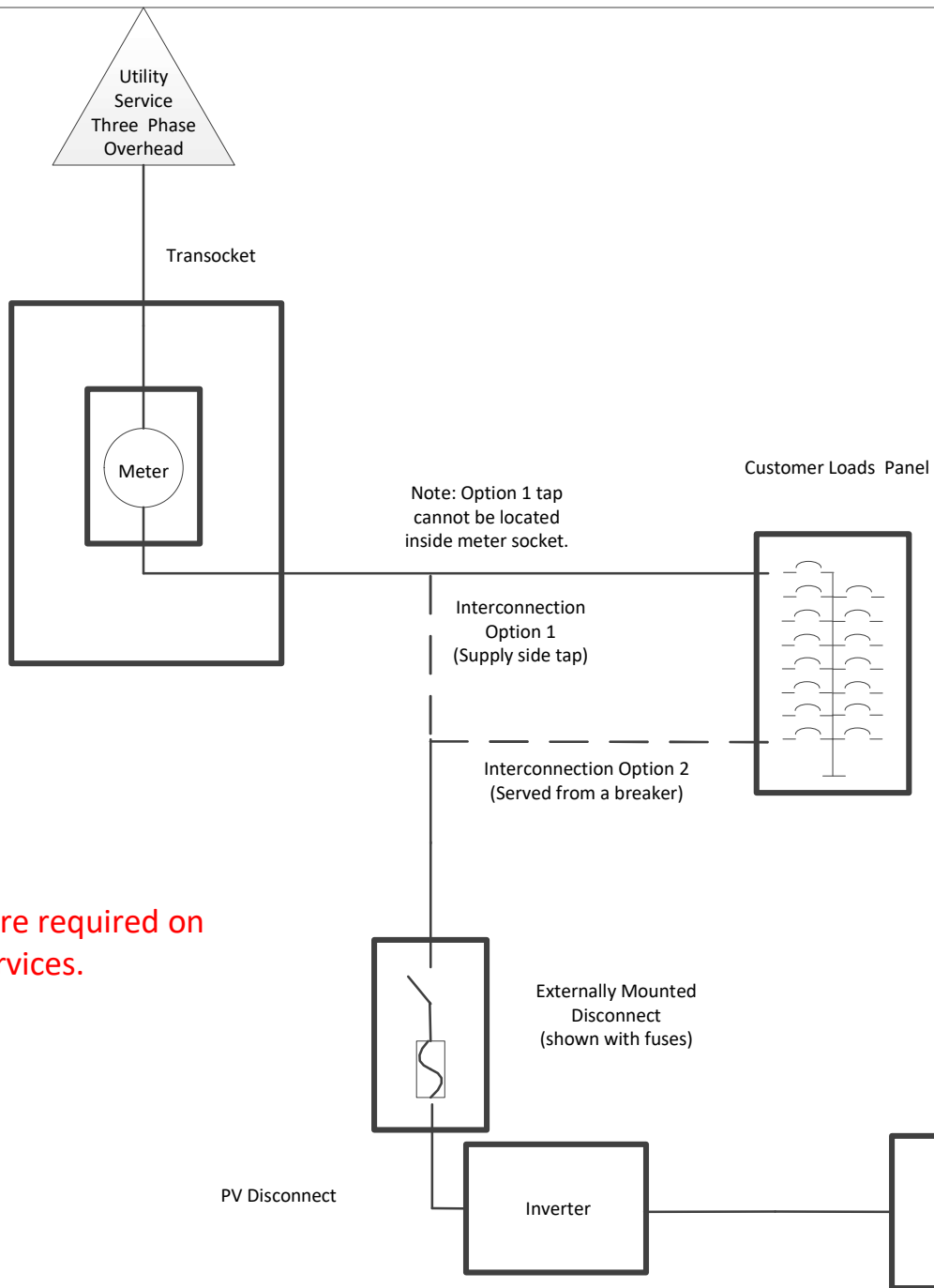

Externally Mounted Disconnect switch shall be rated for the Guaranteed Available Short Circuit Current of the Service.

Three phase inverters are required on three phase services.

Note: One-line diagram must show the metering equipment and disconnect catalog numbers.

One Line Diagram – Non-Purchase Rate – NP13		
Solar with transocket		
(Three Phase Service 400-1200A)		
Drawn: N. Bushman	Date: 4/26/23	Page 13 of 13